

## ADDITIONAL INFORMATION

|  |   |
|--|---|
| *1 - Programming mode / device reset.    | Programming mode is reached by pressing programming button on added / reset device. FAKRO products have programming buttons marked with "P" letter.   |
| *2 - Data copying                        | Irrespective whether you add secondary remote control or transfer primary remote control function, proper names of devices, groups and scenes are not copied. They are changed to default names.  |
| *3 - ADD DEVICE                          | ADD DEVICE function in the ZRS 24 remote control is in Z-Wave settings. Other remote controls – see their manuals.  |
| *4 - LEARNING MODE                       | LEARNING MODE function in the ZRS 24 remote control is in Z-Wave settings. Other remote controls – see their manuals.   |
| *5 - Transfer function                   | Function available only in remote controls with the possibility allowing for remote transfer of changes in settings in the remote control with listening mode function. Each remote control of this type can have a separate name of this function. |
| *6 - GROUP, PLACE AND SCENE MODIFICATION | Modification of GROUPS, PLACES and SCENES possible. CHANGE NAME – change of name. REMOVE FROM (GROUPS, PLACES, SCENES) – removes selected device. REMOVE (GROUP, PLACE, SCENE) – removes added (GROUPS, PLACES, SCENES).                            |
| *7 - LIFE_LINE                           | Non-editable position essential for correct operation of the remote control.  |

## WARRANTY

The manufacturer guarantees correct device functioning. It also undertakes to repair or replace faulty device if damage is a result of material or structural faults. The warranty period is 24 months from the date of purchase, fulfilling the following conditions:

- Installation has been performed as per manufacturer recommendations.
- Seals remain intact and no authorised structural changes have been made.
- The device has been used in accordance with its intended use as per user manual.
- Damage is not a result of improperly made electrical system or atmospheric phenomena.
- The manufacturer is not liable for damage which occurred as a result of improper use or mechanical damage.
- In case of failure, the device must be submitted for repair with a Warranty Card.

Defects revealed within the warranty period will be removed free of charge no longer than 14 days after accepting the product for repair. Warranty and post-warranty repairs are performed by the manufacturer i.e. FAKRO PP. Sp. z o.o.

Quality certificate:  
Device

Model \_\_\_\_\_  
Serial number \_\_\_\_\_  
Seller \_\_\_\_\_  
Address \_\_\_\_\_  
Purchase date \_\_\_\_\_

Fakro Sp. z o.o.  
ul. Węgierska 144A, 33-300 Nowy Sącz, PL  
tel. +48 18 4440444, fax +48 18 4440333  
www.fakro.com

# FAKRO®

## ORIGINAL USER MANUAL

GB

### Remote Control Z-Wave



# ZRS 24



|   |    |
|---|----|
| REMOTE CONTROL PREPARATION  | 3  |
| REMOTE CONTROL MENU SCHEME  | 4  |
| ADDING DEVICE (QUICK START)   | 5  |
| CONTROL MODES   | 7  |
| GROUP CREATION  | 9  |
| PLACE CREATION  | 10 |
| SCENE CREATION  | 12 |
| SCENE MANUAL OPERATION  | 15 |
| REMOVE DEVICE / DEVICE RESET  | 16 |
| REMOTE CONTROL RESET (GROUPS, PLACES, SCENES)                                     | 17 |
| NETWORK RESET (DEVICES)   | 18 |
| ADDING ZRS 24 REMOTE CONTROL (TO OTHER PRIMARY Z-WAVE REMOTE CONTROL OF ANY TYPE) | 19 |
| ADDING ZRS 24 REMOTE CONTROL (TO OTHER PRIMARY ZRS 24 REMOTE CONTROL)             | 20 |
| TRANSFERRING PRIMARY REMOTE CONTROL FUNCTION                                      | 21 |
| WAKE UP FOR 30 SEC.   | 22 |
| REMOTE CONTROL HOLDER INSTALLATION  | 23 |
| PROBLEMS  | 23 |
| ADDITIONAL INFORMATION  | 24 |
| WARRANTY  | 24 |

NC 892-GB IU/ZRS 24/28.12.2016/F

Fakro Sp. z o.o.  
ul. Węgierska 144A, 33-300 Nowy Sącz, PL  
tel. +48 18 4440444, fax +48 18 4440333  
www.fakro.com

Dear Sir/Madam! Thank you for purchasing the product from FAKRO. We do hope that it will meet your expectations. To ensure appropriate functioning of the product, please peruse this User Manual.

Remote control (controller) with a colour display



Remote control holder

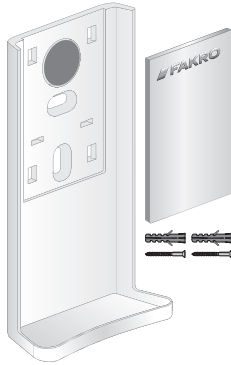

Remote control includes batteries 3x1,2V NiMH AAA.

### REMOTE CONTROL DESCRIPTION

The ZRS 24 is designed for the remote control of devices compatible with the Z-Wave standard. The remote control enables to operate up to 231 devices as well as create and operate groups, places and scenes (description in the relevant chapters).

The Z-Wave network features division into PRIMARY and SECONDARY remote controls.

**i** PRIMARY remote control – used to operate devices, groups, places and scenes. It can change network settings as well as add and remove devices. Only one PRIMARY remote control can be in one network.

**i** SECONDARY remote control – used only to operate. Many SECONDARY remote controls can be in one network.

First remote control added to the Z-Wave network always acts as PRIMARY remote control. Each subsequent remote control added to the network will act as SECONDARY remote control.

**!** NOTE! Remote control cannot be used while charging.

### TECHNICAL SPECIFICATION

**Power supply:**  
3.6V DC, batteries 3x1.2V NiMH AAA – charging using micro USB wire – 5V network charger.  
**Radio protocol:**  
Z-Wave  
**Frequency:**  
EU – 868,42 MHz;  
AS/NZ – 921,42 MHz;  
US/Canada – 908,4 MHz;  
RU – 869 MHz.

**Reach:**  
up to 20m in a building.  
**Working temperature:**  
0-40°C.  
**Screen:**  
2,8", 240x320 px, colour.  
**Weight:**  
0.128kg.  
**Dimensions:**  
180x52x20mm.

### REMOTE CONTROL HOLDER INSTALLATION

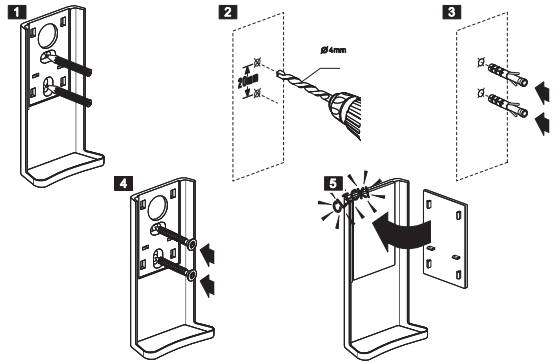

### PROBLEMS

| PROBLEM   | CAUSES / SOLUTIONS  |
|---|---|
| 1. Device cannot be added.  | Restore added device to factory settings using REMOVE DEVICE function. Make sure that the programming button is pressed for no longer than 60 seconds.  |
| 2. Device cannot be removed.  | Make sure that the programming button is pressed on proper device for no longer than 60 seconds.  |
| 3. Next remote control cannot be added to PRIMARY remote control of any type. | Restore added device to factory settings. Make sure that ADD DEVICE function in PRIMARY remote control is run for no longer than 60 seconds.  |
| 4. Next remote control cannot be added to PRIMARY ZRS 24 remote control.      | Restore added device to factory settings. Make sure that LEARNING MODE function in SECONDARY remote control is run for no longer than 60 seconds.   |
| 5. Primary remote control function cannot be transferred.                     | Restore added device to factory settings. Make sure that LEARNING MODE function in SECONDARY remote control is run for no longer than 60 seconds.   |
| 6. Device cannot be added.  | Up to 231 devices can be assigned to the remote control.  |
| 7. Device cannot be added to the group.                                       | Up to 24 devices can be assigned to the group.  |
| 8. Device cannot be added to the place.                                       | Up to 24 devices can be assigned to the place.  |
| 9. Device cannot be added to the scene.                                       | Up to 24 devices can be assigned to the scene.  |
| 10. Scene in which window opens partially cannot be set.                      | Check whether the controlled device has position sensors (encoders). If not, end positions are only available (open/close). No position sensors in the device results in ??? on the screen in the intermediate position, or 0% and 100% in end positions. |
| 11. Scene does not work.  | Go to REMOTE CONTROL SETTINGS. Make sure that TIMERS are on.  |
| 12. Problems with reach.  | Check whether the device is correctly connected to the source of power. Carry out reach test (page 7).  |

## WAKE UP FOR 30 SEC.

**i** Advanced function.

It allows to enter Primary or Secondary controller to the so-called listening mode. In this mode, the remote control enables remote configuration from another controller, e.g. Gateway Z-Wave. Triggering transfer function\*5 – page 24.

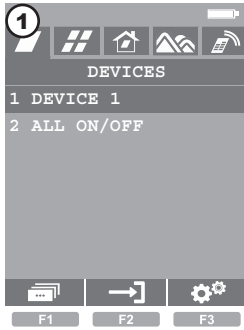

Start screen.



Press F3 button for 3 seconds to enter Z-WAVE SETTINGS.

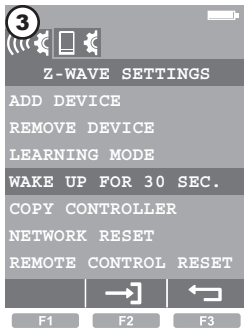

Select WAKE UP FOR 30 SEC. and press F2 or OK button.

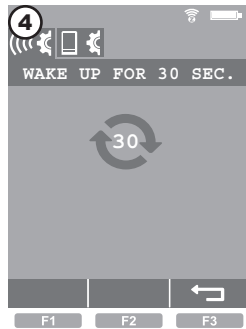

Using other remote control will run transfer function\*5 within 30 seconds – page 24.

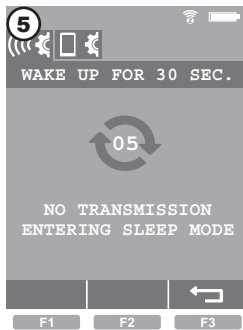

The remote control remains in the listening mode for 30 seconds after the end of data transmission. After this time the remote control automatically enters sleep mode.

## REMOTE CONTROL STRUCTURE

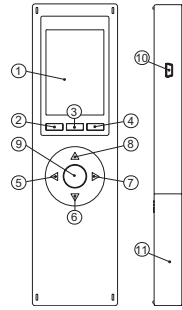

- ① Screen
- ② Function Button F1
- ③ Function Button F2
- ④ Function Button F3
- ⑤ Control Button (Left)
- ⑥ Control Button (Down)
- ⑦ Control Button (Right)
- ⑧ Control Button (Up)
- ⑨ Accept Button (OK)
- ⑩ Charging port USB
- ⑪ Battery cover

## REMOTE CONTROL PREPARATION

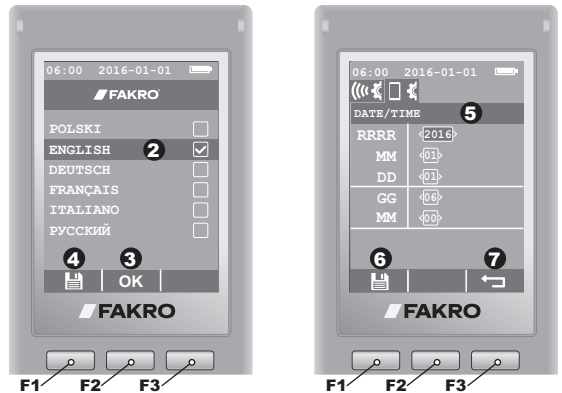
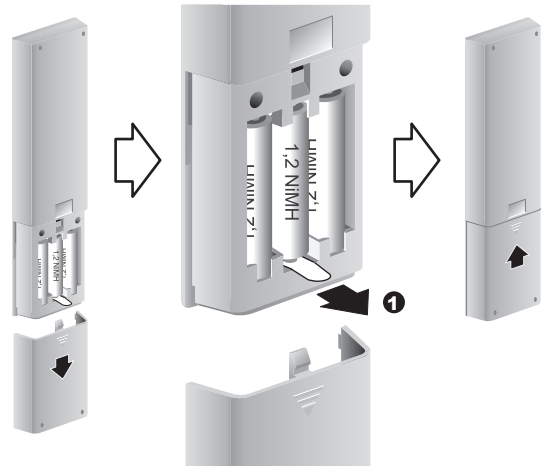

- ① Remove foil, close battery cover  
Remote control will run automatically
- ② Select language using control buttons
- ③ Press accept button OK
- ④ Save using F1 button
- ⑤ Set date using control buttons
- ⑥ Save using F1 button
- ⑦ Exit using F3 button

## REMOTE CONTROL MENU SCHEME

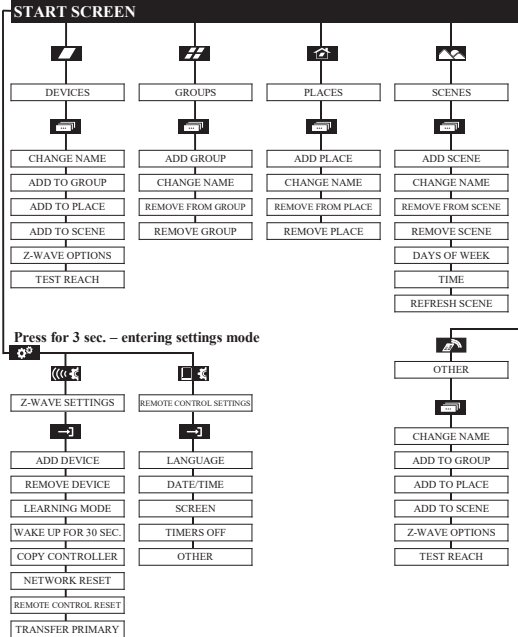

## DESCRIPTION OF MENU ICONS

- DEVICES
- GROUPS
- PLACES
- SCENES
- OTHER
- entering settings mode
- back to previous screen
- entering advanced options mode
- Z-WAVE SETTINGS
- REMOTE CONTROL SETTINGS
- enter
- accepting
- saving settings
- refreshing data
- setting time functions
- transition between settings
- removing entered characters
- REMOVE INOPERATIVE DEVICE
- SUBSTITUTE INOPERATIVE DEVICE

## TRANSFERRING PRIMARY REMOTE CONTROL FUNCTION

The procedure allows to transfer function of PRIMARY remote control to other SECONDARY remote control. It is also possible to transfer this function to the remote control which has not been added yet. Additionally, this procedure sends information about devices\*2 – page 24.



Start screen.



Press F3 button for 3 seconds to enter Z-WAVE SETTINGS.

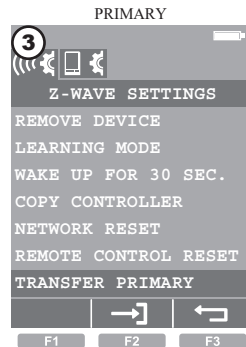

Select TRANSFER PRIMARY and press F2 or OK button.

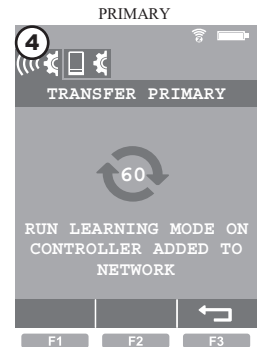

Within 60 seconds run LEARNING MODE\*4 function on SECONDARY remote control (or the one you want to add) – page 24.

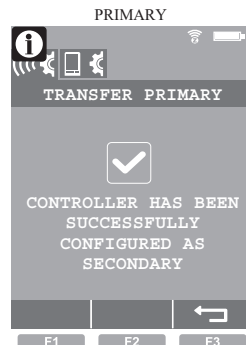

Procedure performed correctly.

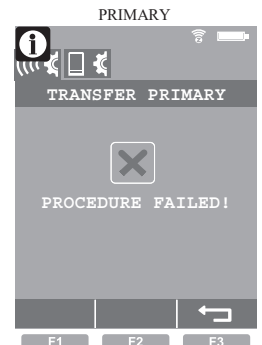

Error. Repeat procedure or see page 23, point 5.

## ADDING ZRS 24 REMOTE CONTROL (TO OTHER PRIMARY ZRS 24 REMOTE CONTROL)

The procedure allows to add the ZRS 24 remote control to the network (as SECONDARY). PRIMARY remote control in this network should be other ZRS 24 remote control. Information about devices, groups and scenes\*2 is additionally sent to added remote control – page 24. Copying will work correctly only in case of ZRS 24 remote controls.



Start screen.

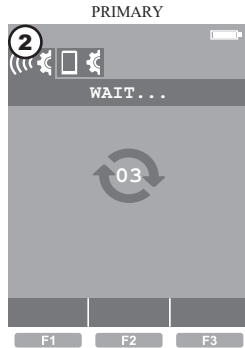

Press F3 button for 3 seconds to enter Z-WAVE SETTINGS.

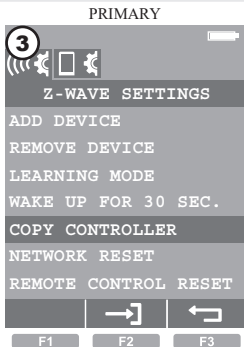

Select COPY CONTROLLER and press F3 or OK button.

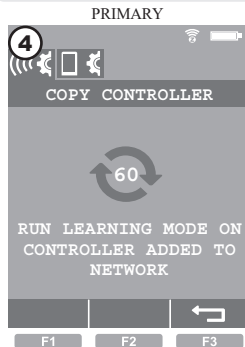

Within 60 seconds run LEARNING MODE\*4 function on SECONDARY remote control (or the one you want to add as SECONDARY) – page 24.



Procedure performed correctly.



Error. Repeat procedure or see page 23, point 4.

## ADDING DEVICE (QUICK START)

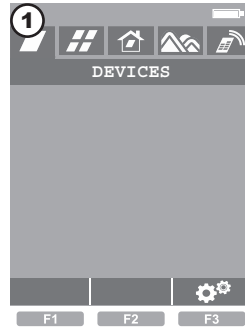

Start screen.



Press F3 for 3 seconds to enter Z-WAVE SETTINGS

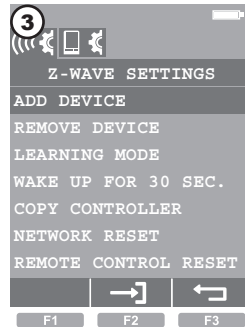

Using control buttons select ADD DEVICE command. Accept using F2 or OK button.

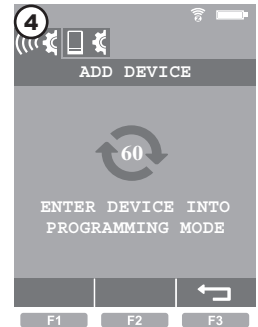

Within 60 seconds enter adding the device into programming mode\*1.

\*1 Programming mode is reached by pressing programming button on the device being added. FAKRO products have programming buttons marked with "P" letter.



Procedure performed correctly.



Error. Repeat procedure or see page 23, point 1.

EXIT – F3 button.

## CHANGING NAME OF ADDED DEVICE

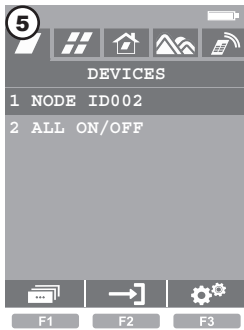

Using control buttons select a device. Press F1 button.

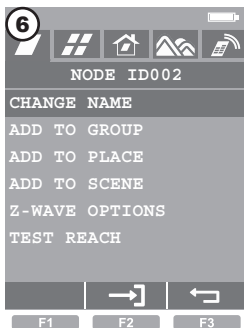

Select CHANGE NAME and press F2 or OK button.



Using control buttons move between characters. Accept selected characters using OK button. Remove characters using F2 button. Save created name (e.g. DEVICE 1) using F1 button.

## CONTROLLING ADDED DEVICE

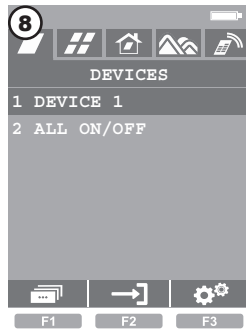

Using control buttons select a device. Press F2 or OK button.

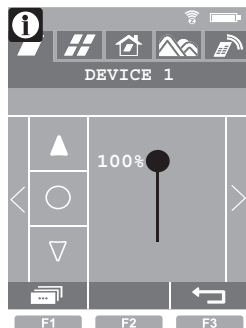

OPENING – Control button “up” (see control modes – page 7).

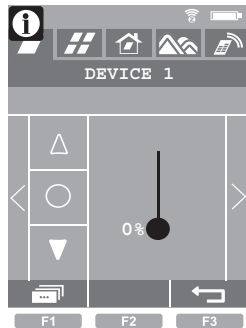

CLOSING – Control button “down” (see control modes – page 7)

STOP – OK button

## ADDING ZRS 24 REMOTE CONTROL (TO OTHER PRIMARY Z-WAVE REMOTE CONTROL OF ANY TYPE)

The procedure allows to add the ZRS 24 remote control to the network (as SECONDARY). SECONDARY remote control in this network can be of any type. Information is additionally sent to added remote control (only about devices\*2 – page 24). Groups, places and scenes are not copied.

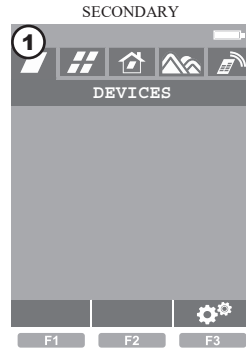

Start screen.



Press F3 button for 3 seconds to enter Z-WAVE SETTINGS.

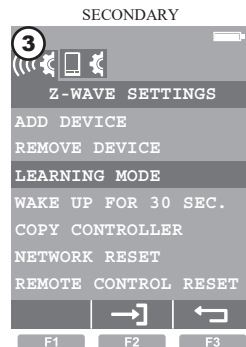

Select LEARNING MODE and press F2 or OK button.

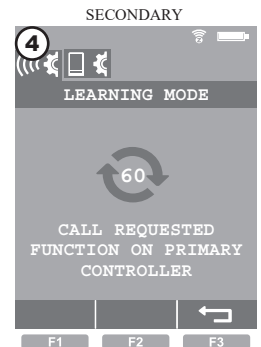

Within 60 seconds run ADD DEVICE\*3 function on PRIMARY controller – page 24.

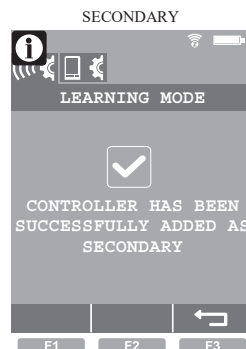

Procedure performed correctly.

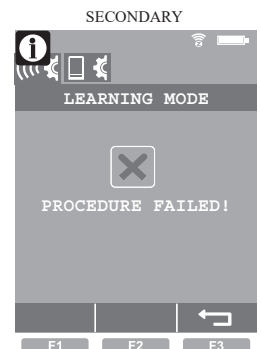

Error. Repeat procedure or see page 23, point 3.

## NETWORK RESET (DEVICES)

NETWORK / PRIMARY REMOTE CONTROL RESET / - deletes information about all added devices. Controlling devices is possible only after removing all devices (page 16) and adding them again (page 7).  
 NETWORK /SECONDARY REMOTE CONTROL RESET/ - deletes information about all added devices. Controlling devices is possible only after ADDING SECONDARY REMOTE CONTROL (page 19 or 20). It is also possible to carry out only TRANSFERING PRIMARY REMOTE CONTROL FUNCTION (page 21).

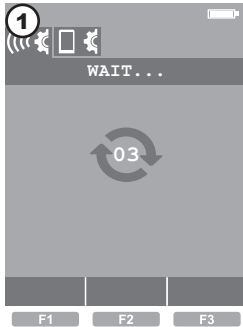

Press F3 button for 3 seconds to enter Z-WAVE SETTINGS.

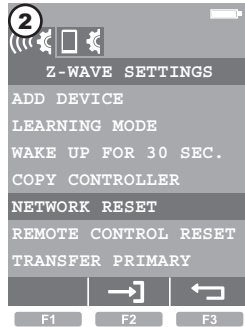

Select NETWORK RESET and press F2 or OK button.

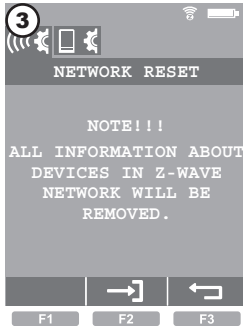

Continue by pressing F2 or OK button.



Accept using F2 or OK button.

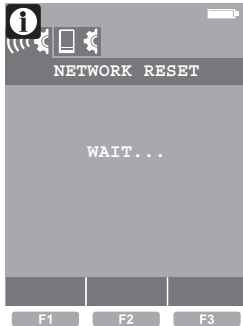

Wait...

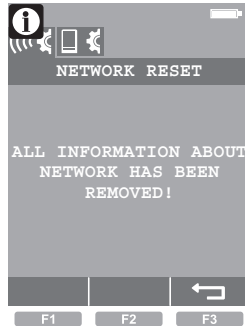

Information deleted. Exit using F3 button.

## CONTROL MODES



**i** **SHORT CONTROL**  
Pressing control button (shorter than 0.5 second) causes continuous action.

**i** **LONG CONTROL**  
Pressing control button (longer than 0.5 second) causes action until release of the button.

**i** **STOP** – Pressing OK button stops the action.

## PROBLEM WITH CONTROL

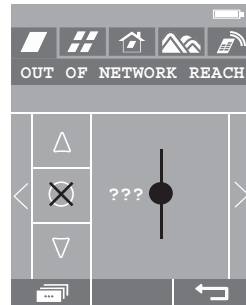

**!** **OUT OF NETWORK REACH**  
Distance between the remote control and device is too big (!) or see page 23, point 12.

**i** **???** it means no position sensors in the device.

## REACH TEST

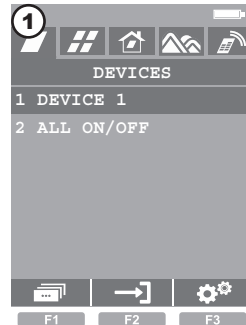

Select a device and press F1 button.

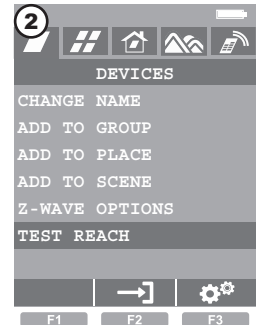

Select TEST REACH and press F2 or OK button. Correct number of frames received: 20-30.

## GROUP CREATION

Adding devices to a group allows for their simultaneous operation. It is possible to create 24 groups. First add groups, then name and add devices to them.

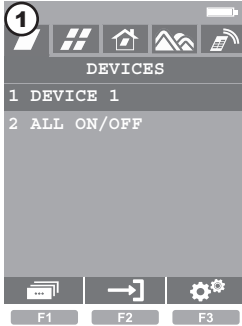

Start screen.

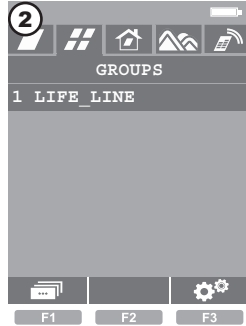

Go to GROUPS section and press F1 button.

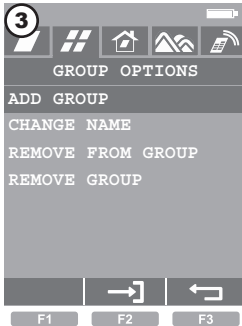

Select ADD GROUP and press F2 or OK button.



Using control buttons and OK name a group (e.g. GROUP 1). Delete characters using F2 button. Save using F1 button.

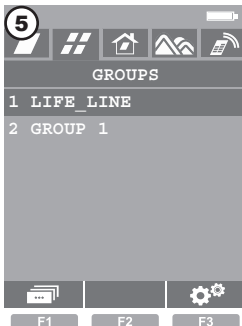

Group has been created.

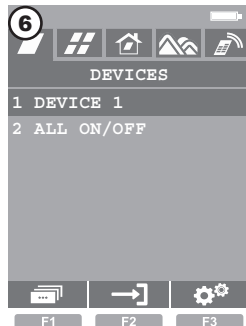

Go to DEVICES section, select a device (e.g. DEVICE 1) and press F1 button.

## REMOTE CONTROL RESET (GROUPS, PLACES, SCENES)

The procedure deletes all information about groups, places and scenes. The procedure does not delete information about devices. To restore factory settings of the remote control, it is required to perform REMOTE CONTROL RESET and NETWORK RESET.

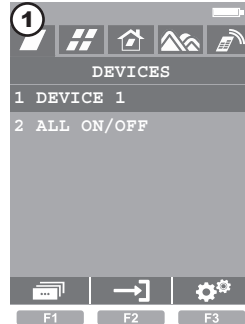

Start screen.



Press F3 button for 3 seconds to enter Z-WAVE SETTINGS.

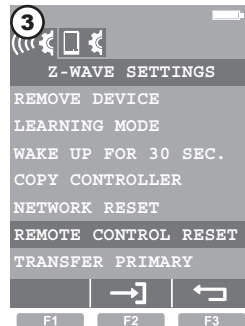

Select REMOTE CONTROL RESET and press F2 or OK button.

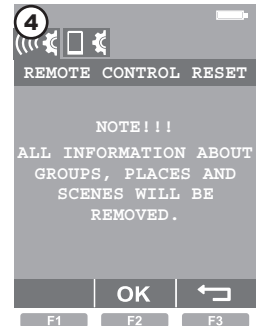

Accept using F2 or OK button.

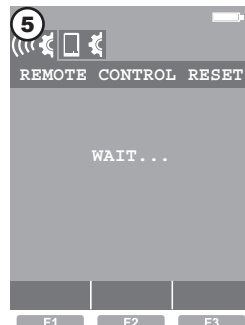

Wait...

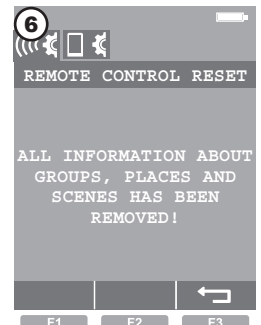

Information deleted. Exit using F3 button.



## REMOVE DEVICE / DEVICE RESET

Removing a device at the level of remote control resets the device (restoring to factory settings).

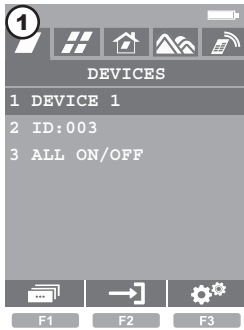

Start screen.



Press F3 button for 3 seconds to enter Z-WAVE SETTINGS.

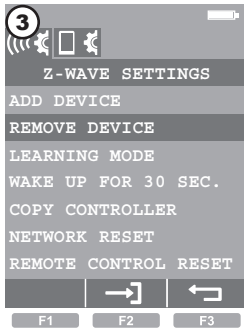

Select REMOVE DEVICE and press F2 or OK button.



Within 60 seconds enter removing the device into programming mode\*1 – page 24.

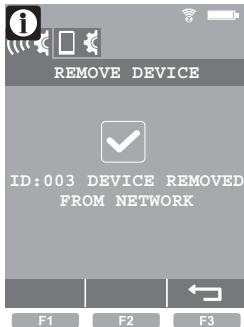

Procedure performed correctly.

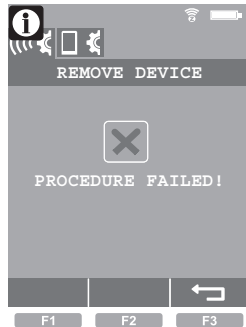

Error. Repeat procedure or see page 23, point 2.

EXIT – press F3 button.

## GROUP CREATION

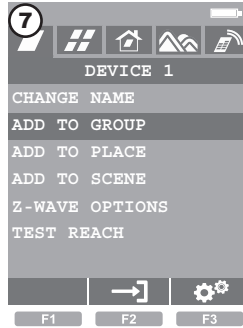

Select ADD TO GROUP and press F2 or OK button.

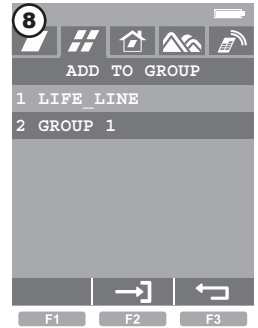

Select group (e.g. GROUP 1) and accept using F2 or OK buttons.

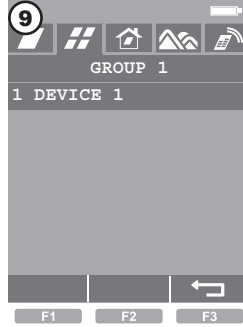

Device has been added to a group. Exit using F3 button.

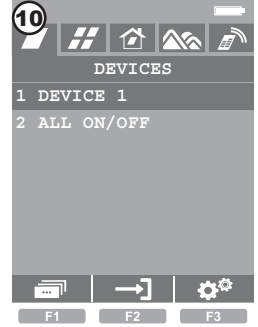

Once the procedure is completed, start screen will appear.

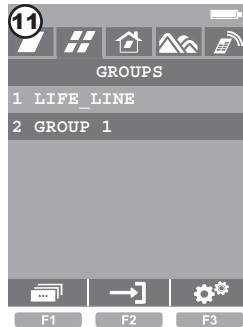

Go to GROUPS section, select group (e.g. GROUP 1) and press F2 button or OK.

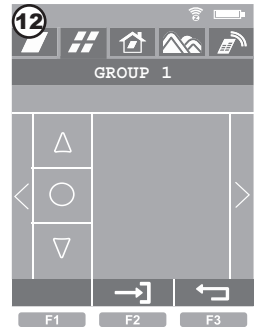

Using UP-DOWN buttons control group of devices. Using LEFT-RIGHT buttons move between groups.

## PLACE CREATION

Adding devices to places allows to operate only those devices which are in the room of the user's interest. Each device is controlled separately. It is possible to create 24 places. First add places, then name and add devices to them.

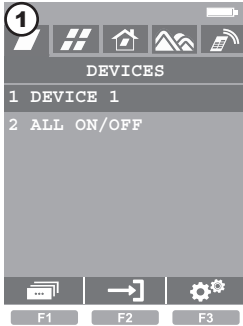

Start screen.

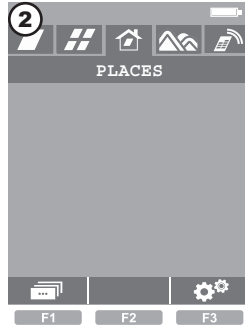

Go to PLACES section and press F1 button.

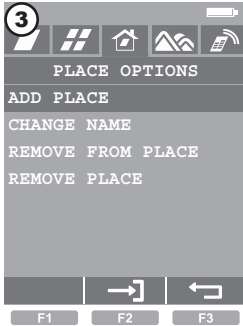

Select ADD PLACE and press F2 or OK button.



Using control buttons and OK name a place (e.g. PLACE 1). Delete characters using 2F button. Save using F1 button.



Place has been created.

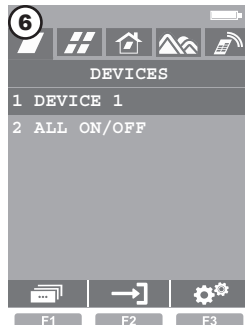

Go to DEVICES section, select a device (e.g. DEVICE 1) and press F1 button.

## SCENE MANUAL OPERATION

### POSSIBLE AFTER HAVING EARLIER CREATED SCENES!

It is possible to manually turn on a particular scene at any time. The user can run opening windows and shutters earlier than it has been planned (e.g. before 09:00).



Manual run of a scene causes action with omitting time settings.

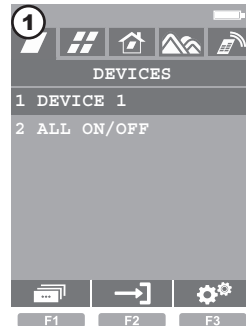

Start screen.



Go to SCENES section, select a scene which you want to turn on and press F2 or OK button.



Irrespective of highlighted device press F2 or OK button. Scene will be immediately run.

## SCENE CREATION

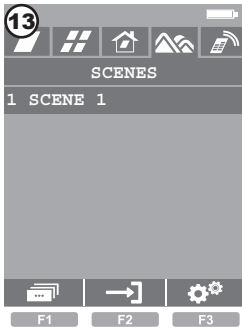

Go to SCENE section, select a scene (e.g. SCENE 1) and press F1 button.

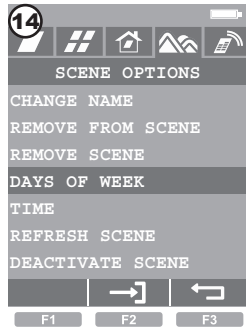

Select DAYS OF WEEK and select F2 or OK button.

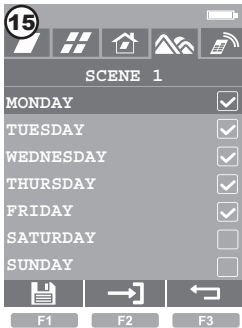

Mark selected days using F2 or OK button and then save using F1 button.

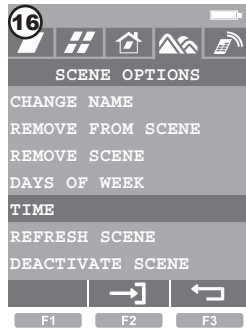

Select TIME and press F2 or OK button.



Using control buttons change hour and then save using F1 button.

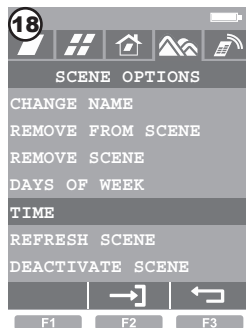

Exit settings using F3 button.

In case the scene does not work, see page 23, point 11.

## PLACE CREATION

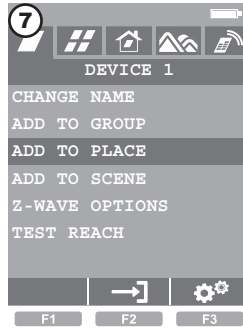

Select ADD TO PLACE and press using F2 or OK button.



Select a place (e.g. PLACE 1) and accepting using F2 or OK button.



Device has been added to the place. Exit using F3 button.



Once the procedure is completed, start screen will appear.

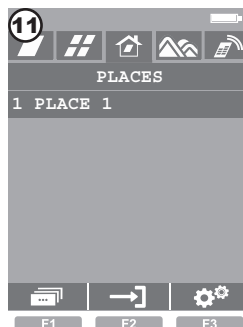

Go to PLACES section, select a place (e.g. PLACE 1) and press F2 or OK button.



Choose a device which you want to operate (e.g. DEVICE 1) and accept using F2 or OK button.

## SCENE CREATION

Adding devices to scenes allows for automatic or manual operation of many devices (e.g. shutters, actuators, lighting, switches). It is possible to set a scene in which windows and shutters will open at 09:00 from Monday to Friday. It is possible to create 24 scenes. First add scenes, then name and add devices to them.

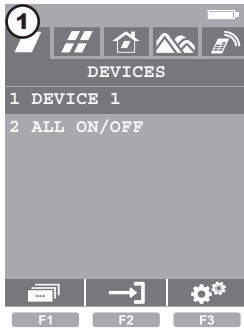

Start screen.

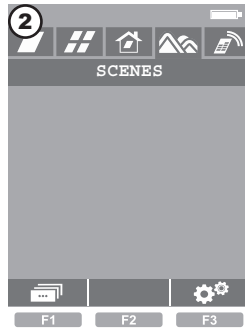

Go to SCENES section and press F1 button.

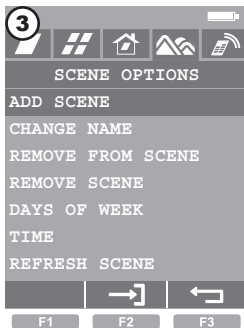

Select ADD SCENE and press F2 or OK button.

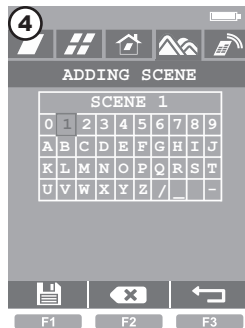

Using control buttons and OK name a scene (e.g. SCENE 1). Delete characters using F2 button. Save using F1 button.

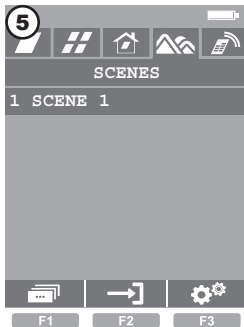

Scene has been created.

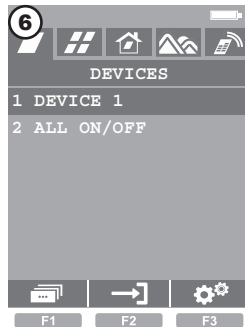

Go to DEVICES section, select a device (e.g. DEVICE 1) and press F2 or OK button.

## SCENE CREATION

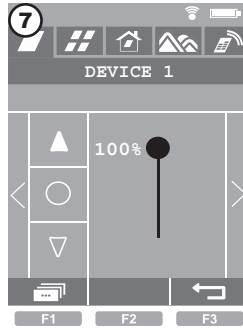

Using control buttons set a device in a position of scene completion (e.g. 100% opening) and press F1 button.

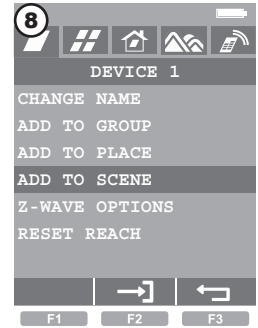

Select ADD TO SCENE and press F2 or OK button.

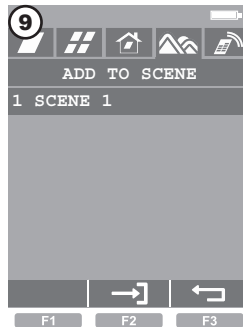

Select a scene (e.g. SCENE 1) and accept using F2 or OK button.



Device has been added to a scene. Exit using F3 button.

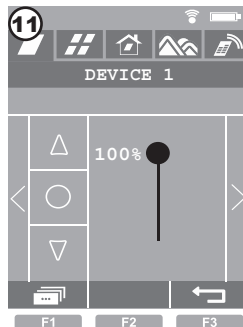

Press F3 button again.



Start screen appeared.